

Blocco: MAIN  
 Autore:  
 Data di creazione: 12.03.2010 14:25:52  
 Ultima modifica: 24.05.2012 21:29:26

| Simbolo | Tipo variabile | Tipo di dati | Commento |
|---------|----------------|--------------|----------|
|         | TEMP           |              |          |
|         | TEMP           |              |          |
|         | TEMP           |              |          |
|         | TEMP           |              |          |

### SEMAFORO (USO DIDATTICO)

I0.0 quando attivato esclude modalità "semaforo intelligente"  
 I0.1 fotocellule presenza veicoli sulla striscia di arresto strada 2  
 I0.2 fotocellule presenza veicoli sulla striscia di arresto strada 1  
 I0.3 pulsanti per attraversamento pedoni strada 2  
 I0.4 pulsanti per attraversamento pedoni strada 1  
 I0.5 selettore semaforo lampeggiante

#### Segmento 1 Titolo del segmento

M0.0 = verde strada 1 (condizione iniziale)

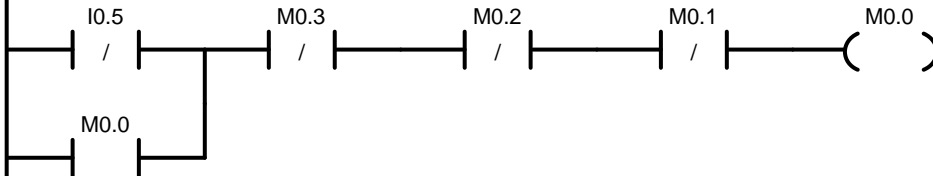

#### Segmento 2

Durata verde (10 sec) - Green lamp delay

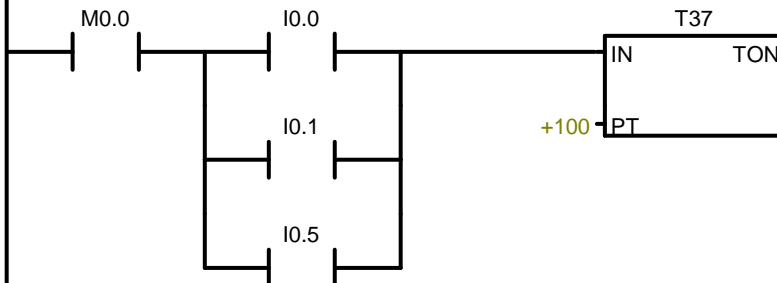

**Segmento 3**

M0.1 giallo strada 1

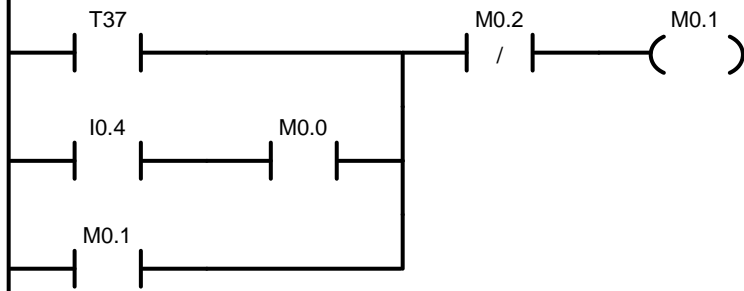
**Segmento 4**

Durata giallo (3 sec) - Yellow lamp delay

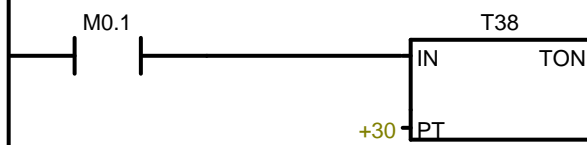
**Segmento 5**

M0.2 verde strada 2

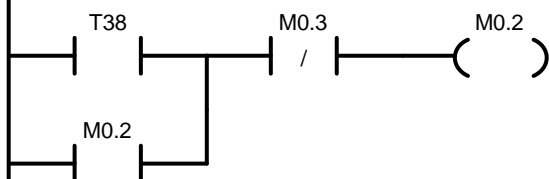
**Segmento 6**

Durata verde - Green lamp delay

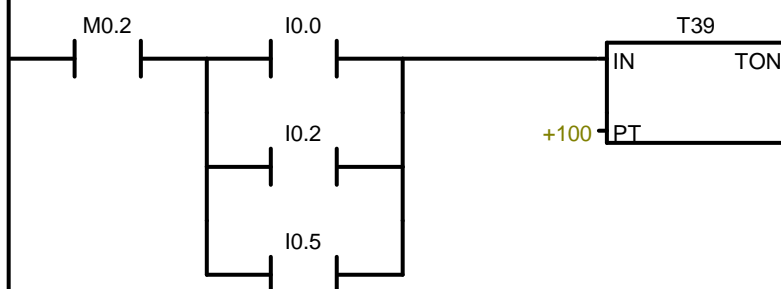

**Segmento 7**

M0.3 giallo strada 2

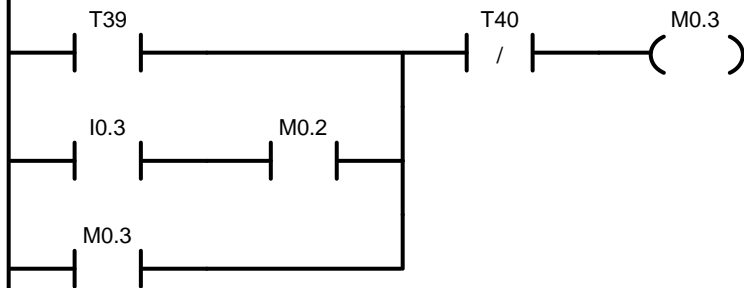
**Segmento 8**

Durata giallo - Yellow lamp delay

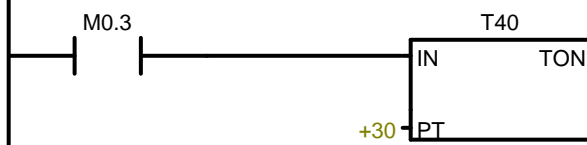
**Segmento 9**

Verde strada 1 - Green lamp road 1

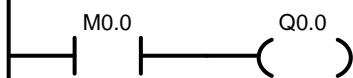
**Segmento 10**

Giallo strada 1 - Yellow lamp road 1

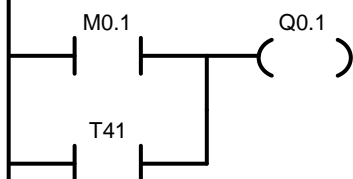
**Segmento 11**

Rosso strada 1 - Red lamp road 1

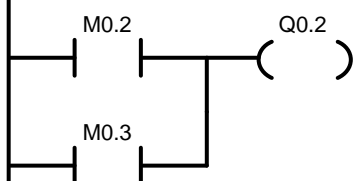

**Segmento 12**

Verde strada 2 - Green lamp road 2

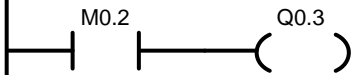

**Segmento 13**

Giallo strada 2 - Yellow lamp road 2

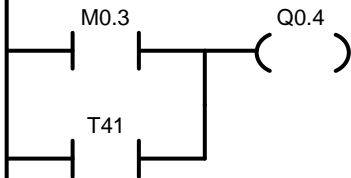

**Segmento 14**

Rosso strada 2 - Red lamp road 2

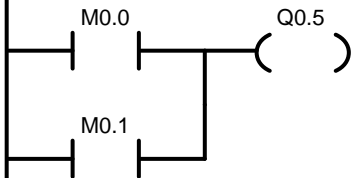

**Segmento 15**

Semaforo lampeggiante (0,5 sec)

When I0.5 is ON the yellow lamps are in astable condition. The pause can be set by T41-T42

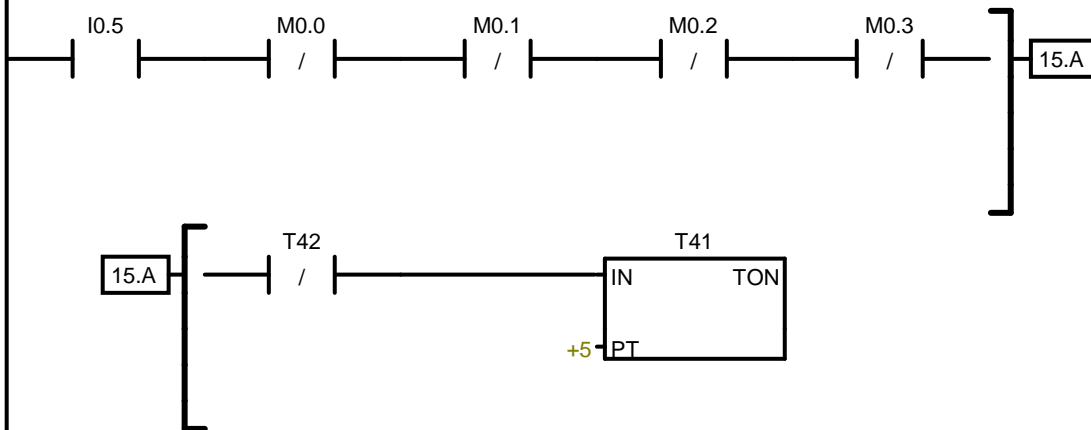

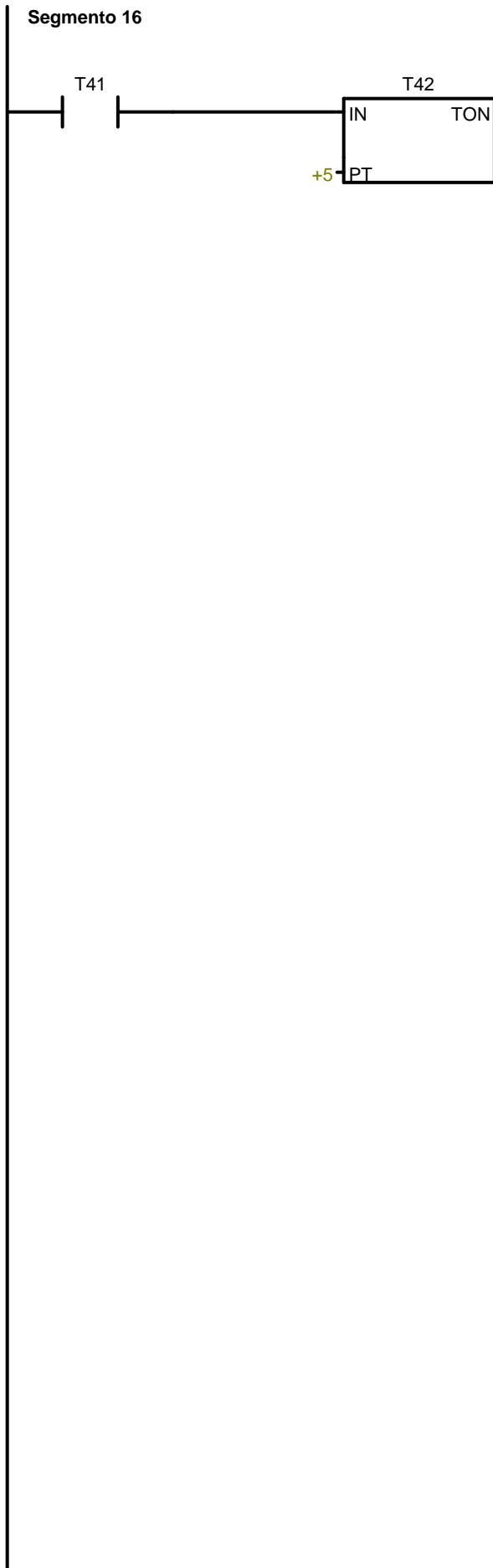

Blocco: SBR\_0  
Autore:  
Data di creazione: 12.03.2010 14:25:52  
Ultima modifica: 12.03.2010 14:25:52

| Simbolo | Tipo variabile | Tipo di dati | Commento |
|---------|----------------|--------------|----------|
| EN      | IN             | BOOL         |          |
|         | IN             |              |          |
|         | IN_OUT         |              |          |
|         | OUT            |              |          |
|         | TEMP           |              |          |

COMMENTI DEL SOTTOPROGRAMMA

**Segmento 1** Titolo del segmento

Commento del segmento

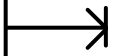

Blocco: INT\_0  
Autore:  
Data di creazione: 12.03.2010 14:25:52  
Ultima modifica: 12.03.2010 14:25:52

| Simbolo | Tipo variabile | Tipo di dati | Commento |
|---------|----------------|--------------|----------|
|         | TEMP           |              |          |
|         | TEMP           |              |          |
|         | TEMP           |              |          |
|         | TEMP           |              |          |

COMMENTI DELLA ROUTINE DI INTERRUPT

**Segmento 1** Titolo del segmento

Commento del segmento

